



**Durable,
Long-lasting
Punches &
Punch Blanks**

TUFFPUNCH[®]



Global leader in
providing fabrication
and stamping solutions

a MISUMI Group Company

www.daytonprogress.com



**Heads-
above-the-rest
performance**

TuffPunch® Punches and Punch Blanks

Product Applications

Dayton Progress **TuffPunch® Punches** and **Punch Blanks** are Kommercial quality products manufactured with thicker, larger, and 10° angled diameter heads, and are designed to reduce punch load and significantly lower failure rates when using heavy gauge and high tensile material. (See p. 3 for additional information.) TuffPunch® products are well-suited for high-demand industries where frequency and heavier-than-normal impact punching activity occurs and where optimum performance is required.

Dayton's TuffPunch® product line includes: **Dayton Jektole® Punches; Regular Punches; Center Dowel Punches; Punch Blanks;** and **Retainers**. Both standard sizes and standard alterations are shown in this catalog.

Minimizes Head Failure

All Dayton TuffPunch® products are designed with a 10°-angled head with a diameter equal to the shank diameter (see photo). This design allows the perforating forces to travel up from the shank and completely through the head. This eliminates the lateral shock waves that would otherwise put stress on the outer edge of the head, resulting in frequent failures—especially in heavy-duty applications.

In addition, Dayton TuffPunch® products are available in *common shear angle configurations* to reduce punch load and minimize the risk of slug pulling. Shear angle configurations include: chamfer; conical; double shear; and single shear. For more information, see "Standard Alterations" on p. 9.



Cryogenic Treatment Standard

DayKool™ (XCR)—a cryogenic steel conditioning process used primarily with hard, thick materials to improve strength, toughness, and dimensional stability—is **standard** on all Dayton TuffPunch® products.

The DayKool™ process utilizes a liquid nitrogen vapor to cool the steel to -184° C (-300° F), which creates metallurgical changes in the structure that disperse carbides throughout the metal. The result: increased wear resistance (finely dispersed carbides provide more evenly distributed wear); less sharpening time; no loss of resistance after sharpening; longer die runs; and less downtime.

Surface Coatings

Punches can be coated to increase material hardness, reduce galling, and improve wear/and or corrosion resistance.

Abrasive Wear

DayTiN® (XNT)—PVD coating provides excellent wear resistance and lubricity. Not recommended for stainless steel, copper, or nickel. A good general-purpose coating. Approx. hardness: *Vickers 2300.

TiCN (XCN)—ultra-hard (harder than carbide), thin PVD coating. Provides superior abrasive wear resistance and lubricity. Well-suited for stainless steel, nickel, and copper. Approx. hardness: *Vickers 3000.

DayTAN™ (XAN)—ultra-hard (harder than carbide), high-aluminum PVD coating. Provides high temperature resistance. Well-suited for applications where surface heat is generated. Ideal for HSLA, dual phase, and TRIP steels. Approx. hardness: *Vickers 3400.

ZertonPlus™ (XNA)—PVD coating with superior hardness (harder than carbide); provides superior abrasive wear resistance and excellent lubricity. Provides highest temperature resistance, thermal shock stability, & hot hardness. Approx. hardness: *Vickers 3200.

Adhesive Wear

XNM—a solid PVD lubricant coating. Provides both lubricity and wear resistance not available from other PVD or CVD processes. Ideal for aluminum, pre-painted, and galvanized steels. Approx. hardness: *Vickers 2000.

XCD—diamond-like carbon coating. Combines high hardness with an extremely low coefficient of friction. Good protection against abrasive and adhesive wear. Ideal for aluminum. Approx. hardness: *Vickers 2500.

Extrusion Coatings

XNP—the ultimate coating for improved resistance to galling; excellent wear resistance, superior surface finish, and high lubricity. Ideal for extruding and forming applications. Tolerance is ±.0002". Approx. hardness: *Vickers 3100.

XNAProgress (XNAP)—ultra-hard PVD coating that absorbs shear stress; provides excellent high-temperature resistance. Ideal for stamping where tools are exposed to extreme stress profiles. A good alternative to TD coating without the dimensional changes associated with that process. Approx hardness: *Vickers 3200.

Miscellaneous Coating

DayTride® (XN)—a low temperature, cost-effective surface application that treats all exposed surfaces. Provides increased dimensional stability. Ideal for punches and die buttons. Approx. hardness: RC73.

CRN—excellent adhesion, high toughness, and good corrosion resistance. Primary applications are metal forming (copper, brass, & bronze), metal die casting, and plastic injection molding. Approx. hardness: *Vickers 1800-2100.

*Vickers used when RC exceeds 80.

TuffPunch®, DayKool™, DayTAN™, ZertonPlus™, Daytride® and DAYTiN® are trademarks of Dayton Progress Corp.

©2013 Dayton Progress Corporation. All rights reserved.

Center Dowel Punches & Retainers

This catalog contains Center Dowel Punches (Jektole® and Regular) and TuffPunch® Single Head Punch Retainers, designed specifically to be used with all TuffPunch® punches. Only one dowel is required for round punches, reducing machining time by up to 50%. The in-line center dowel assures precise punch-to-matrix alignment, giving you higher quality parts, longer punch life, and reduced downtime. Shaped punches use a secondary dowel for precise alignment.



Use of the TuffPunch® Center Dowel Punch and Retainer eliminate hand-fitting, cutting mounting time by nearly 50%. Simply pull the retainer from its box, and screw it into the die set. This heads-above-the-rest TuffPunch® combination gives you true dimensional accuracy every time.

Ordering Information

Each page contains detailed instructions on how to order specific Dayton TuffPunch® products. Individual drawings show product shape, dimensions, tolerances, and concentricity. When ordering, you are asked to specify quantity, type, shank and length codes (for example), and other applicable data.

HOW TO ORDER

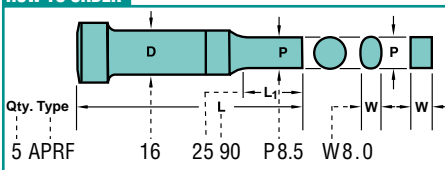

In the example above, the type specified is "APRF." "A" stands for Press-Fit, "P" stands for regular punch, "R" stands for rectangle, and "F" stands for TuffPunch®. 16 is the shank diameter. 25 is the point length, and 90 is the overall length. P 8.5 represents the point dimension, and W 8.0 represents the point width, when applicable.

Standard Alterations

Punches, retainers, and punch blanks are available in sizes other than those listed in the catalog. These special order products can be manufactured for a slight additional charge.

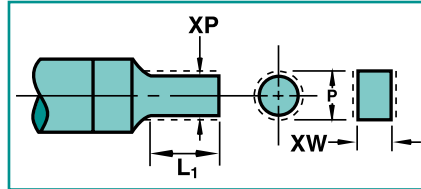

When ordering, you are asked to specify different designations for various non-standard dimensions. For example, if the P & W dimensions are smaller than standard, an "X" must be placed in front of the P or W dimension, e.g., "XP" and "XW." If the point length is longer than standard, designate "XBR" for the point length. The sample drawing above is from the "Standard Alterations" section on p. 9.

Other special order designations include: "XL" for overall length shortened; "XK" for no side hole and no components (for air ejection of slugs); and other special designations for surface coatings.

Product Designation

When ordering, you are asked to specify quantity, product type, length codes, and point or hole size (for example). In addition, use the following chart to define the product as a part number.

Description			
APXF	Line	A for Press-Fit	
	Product	P for Punch (Regular)	
	Shape	X for Round	
	Code	F for TuffPunch®	
16	Press-Fit Dia. D	(shank diameter)	
19	Point Length (L ₁)		
80	Overall Length		
Product Type	Series Catalog Number	Length	Point or Hole Size Dimensions, as specified
APXF	16 19	80	P8.3

Jektole® Punches and Clearances

Jektole®—Dayton's slug ejection punch—permits doubling punch to matrix clearance; produces up to three times the number of hits between sharpenings; and reduces burr heights. Jektole® is available in TuffPunch® Punches and Punch Blanks. For additional information on standard sizes and standard alterations, see pp. 4 and 9.



Jektole® with Keeper Key

Special Features

There are several features that contribute to minimizing failures. In addition to the head design and large fillet under the head, all punch shapes with sharp corners will have a carefully blended radius ground to reduce loading on the punch. The reduced load and standard cryogenic treatment result in fewer punch point problems caused by chipping, wear, or breakage.

TuffPunch® Jektole® Punches

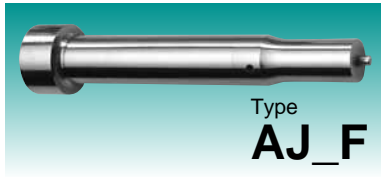

Material

Steel: PS4 (CPM M4), RC 60-62
Heads RC 40-55

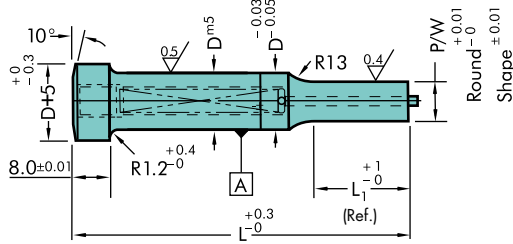

HOW TO ORDER

Specify:	Qty.	Type	D Code	L	P (or P&W) Dimension
Example:	6	AJXF	16	19-80	P 10.3
	12	AJRF	16	25-80	P 10.5, W 8.0
	10	AJLF	16	19-90	P 10.2, W 7.2

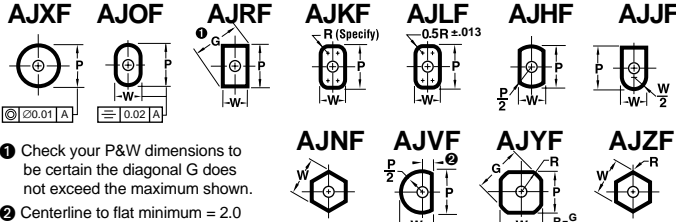

- 1 Check your P&W dimensions to be certain the diagonal G does not exceed the maximum shown.
- 2 Centerline to flat minimum = 2.0 for J6 and 3.0 for J9.

Note: Sharp corners will have a 0.13 radius to minimize wear.

Note: The standard location of a key flat is parallel to the P dimension. For additional information, see p. 10.

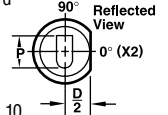

Standard Alterations

See p.9 for additional ordering instructions.

Shank D	Point Std.	Length Alt.	Type & D AJXF	Range P	Type & D AJ_F	Min. W	Max. P/G	L						Jektole® Group
								50	60	70	80	90	100	
08	13	19	AJXF 08	4.00 – 7.99	AJ_F 08	4.00 – 8.00	●	●	●	●	●	●	J4M	
10	13	19	AJXF 10	5.00 – 9.99	AJ_F 10	5.00–10.00	●	●	●	●	●	●	J6M	
13	13	19	AJXF 13	6.00–12.99	AJ_F 13	6.00–13.00	●	●	●	●	●	●	J6M	
16	19	25	AJXF 16	10.00–15.99	AJ_F 16	6.00–16.00	●	●	●	●	●	●	J9M	
20	19	25	AJXF 20	13.00–19.99	AJ_F 20	6.00–20.00	●	●	●	●	●	●	J9M	
25	19	25	AJXF 25	18.00–24.99	AJ_F 25	6.00–25.00	●	●	●	●	●	●	J9M	

Note: *DayKool™ (XCR)*—a cryogenic steel conditioning process used primarily with hard, thick materials to improve strength, toughness, and dimensional stability—is standard on all Dayton TuffPunch® products. For additional information, see p. 2.

- When L = 50, L₁ is 8.0.
- Alternate point length not available.

Surface Coatings

See p.2 for details.

Code/Added Delivery	
XCN —TiCN	+3 days
XN —DayTride®	+3 days
XNT —DayTiN®	+3 days



Round 1 Day
Shape 2 Days

TuffPunch® Jektole® Punch Blanks

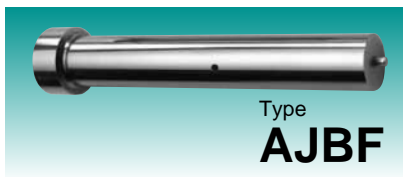

Material

Steel: PS4 (CPM M4), RC 60-62
Heads RC 40-55

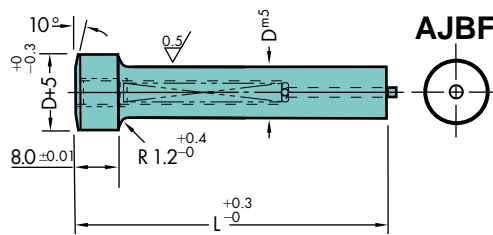

Jektole® side hole position allows alternate point lengths shown on AJ_F above.

HOW TO ORDER

Specify:	Qty.	Type	D Code	L
Example:	6	AJBF	20	80

Standard Alterations

See p.9 for additional ordering instructions.

Shank D	Catalog Number	L						Jektole® Group
		50	60	70	80	90	100	
08	AJBF 08	●	●	●	●	●	●	J4M
10	AJBF 10	●	●	●	●	●	●	J6M
13	AJBF 13	●	●	●	●	●	●	J6M
16	AJBF 16	●	●	●	●	●	●	J9M
20	AJBF 20	●	●	●	●	●	●	J9M
25	AJBF 25	●	●	●	●	●	●	J9M

Note: *DayKool™ (XCR)*—a cryogenic steel conditioning process used primarily with hard, thick materials to improve strength, toughness, and dimensional stability—is standard on all Dayton TuffPunch® products. For additional information, see p. 2.



Blanks 1 Day

Surface Coatings

See p.2 for details.

Code/Added Delivery	
XCN —TiCN	+3 days
XN —DayTride®	+3 days
XNT —DayTiN®	+3 days

TuffPunch® Regular Punches

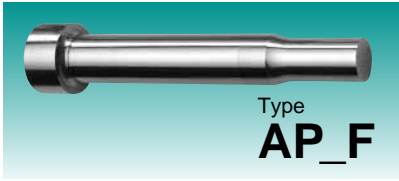

Type
AP_F

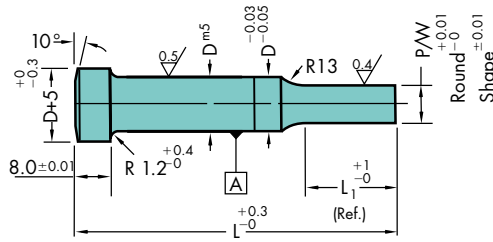

HOW TO ORDER

Specify:	Qty.	Type	D Code	L	P (or P&W) Dimension
Example:	6	APXF	16	19-80	P 10.3
	12	APRF	16	25-80	P 10.5, W 8.0
	10	APLF	16	19-70	P 10.2, W 7.2

Material
Steel: PS4 (CPM M4), RC 60-62
Heads RC 40-55

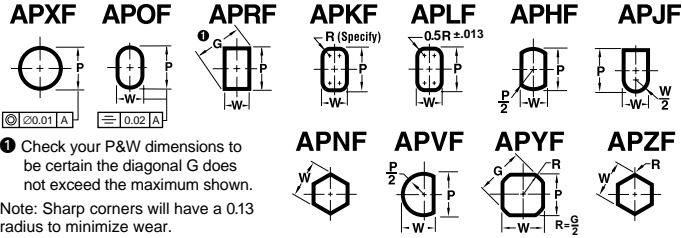

Note: The standard location of a key flat is parallel to the P dimension. For additional information, see p.10.

Standard Alterations
See p.9 for additional ordering instructions.

Shank D	Point Length L ₁		Type & D APXF	Range P	Type & D AP_F	Min. W	Max. P/G	L					
	Std.	Alt.						50	60	70	80	90	100
08	13	19	APXF 08	3.00 – 7.99	AP_F 08	3.00 – 8.00	●	●	●	●	●	●	
10	13	19	APXF 10	3.00 – 9.99	AP_F 10	3.00–10.00	●	●	●	●	●	●	
13	13	19	APXF 13	6.00–12.99	AP_F 13	3.00–13.00	●	●	●	●	●	●	
16	19	25	APXF 16	10.00–15.99	AP_F 16	4.00–16.00	●	●	●	●	●	●	
20	19	25	APXF 20	13.00–19.99	AP_F 20	5.00–20.00	●	●	●	●	●	●	
25	19	25	APXF 25	18.00–24.99	AP_F 25	6.00–25.00	●	●	●	●	●	●	

Surface Coatings
See p.2 for details.

Code/Added Delivery	
XCN —TiCN	+3 days
XN —DayTride®	+3 days
XNT —DayTiN®	+3 days

FDS
FIRM DELIVERY SCHEDULE
Round 1 Day
Shape 2 Days

Note: *DayKool™ (XCR)*—a cryogenic steel conditioning process used primarily with hard, thick materials to improve strength, toughness, and dimensional stability—is standard on all Dayton TuffPunch® products. For additional information, see p. 2.

- When L = 50, L₁ is 8.0.
- Alternate point length not available.

TuffPunch® Regular Punch Blanks



Type
APBF

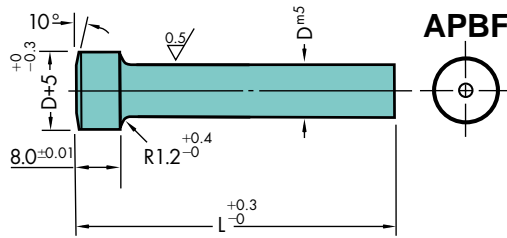

HOW TO ORDER

Specify:	Qty.	Type	D Code	L
Example:	6	APBF	20	80

Standard Alterations
See p.9 for additional ordering instructions.

Material
Steel: PS4 (CPM M4), RC 60-62
Heads RC 40-55

Shank D	Catalog Number	L					
		50	60	70	80	90	100
08	APBF 08	●	●	●	●	●	●
10	APBF 10	●	●	●	●	●	●
13	APBF 13	●	●	●	●	●	●
16	APBF 16	●	●	●	●	●	●
20	APBF 20	●	●	●	●	●	●
25	APBF 25	●	●	●	●	●	●

Note: *DayKool™ (XCR)*—a cryogenic steel conditioning process used primarily with hard, thick materials to improve strength, toughness, and dimensional stability—is standard on all Dayton TuffPunch® products. For additional information, see p. 2.

FDS
FIRM DELIVERY SCHEDULE
Blanks 1 Day

Surface Coatings
See p.2 for details.

Code/Added Delivery	
XCN —TiCN	+3 days
XN —DayTride®	+3 days
XNT —DayTiN®	+3 days

TuffPunch® Jektol® Center Dowel Punches

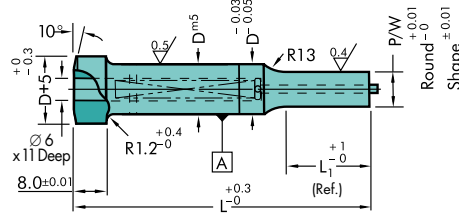
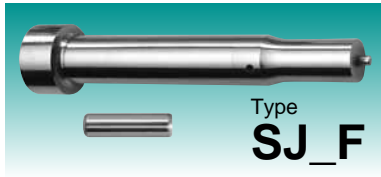

HOW TO ORDER

Specify:	Qty.	Type	D Code	L	P (or P&W) Dimension
Example:	10	SJXF	20	80	P 13.3
	10	SJRF	25	80	P 14.5, W 8.0
	16	SJLF	20	90	P 13.2, W 7.2

Material
Steel: PS4 (CPM M4), RC 60-62
Heads RC 40-55

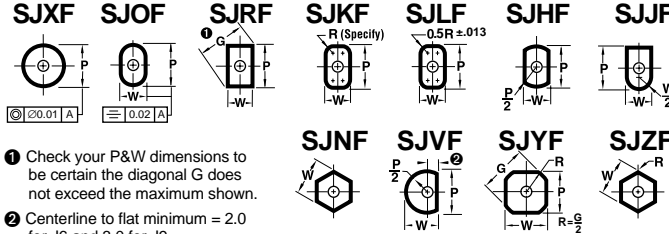

- Check your P&W dimensions to be certain the diagonal G does not exceed the maximum shown.
- Centerline to flat minimum = 2.0 for J6 and 3.0 for J9.

Note: Sharp corners will have a 0.13 radius to minimize wear.

Note: The standard location of a key flat is parallel to the P dimension. For additional information, see p.10.

Standard Alterations
See p.9 for additional ordering instructions.

Shank D	Point Length Std.	Point Length Alt.	Type & D SJXF	Range P	Type & D SJ_F	Min. W	Max. P/G	L					Jektol® Group
								80	90	100	110	120	
10	13	19	SJXF 10	5.0 – 9.99	SJ_F 10	5.00–10.00	●	●	●	●	●	●	J6M
13	13	19	SJXF 13	6.0–12.99	SJ_F 13	6.00–13.00	●	●	●	●	●	●	J6M
16	19	25	SJXF 16	10.0–15.99	SJ_F 16	6.00–16.00	●	●	●	●	●	●	J9M
20	19	25	SJXF 20	13.0–19.99	SJ_F 20	6.00–20.00	●	●	●	●	●	●	J9M
25	19	25	SJXF 25	18.0–24.99	SJ_F 25	6.00–25.00	●	●	●	●	●	●	J9M
32	19	25	SJXF 32	20.0–31.99	SJ_F 32	6.00–32.00	●	●	●	●	●	●	J9M
38	19	25	SJXF 38	28.0–37.99	SJ_F 38	6.00–38.00	●	●	●	●	●	●	J9M
45	19	25	SJXF 45	35.0–44.99	SJ_F 45	6.00–45.00	●	●	●	●	●	●	J9M

Surface Coatings
See p.2 for details.

Code/Added Delivery	Days
XCN —TiCN	+3 days
XN —DayTride®	+3 days
XNT —DayTiN®	+3 days

Note: *DayKool™ (XCR)*—a cryogenic steel conditioning process used primarily with hard, thick materials to improve strength, toughness, and dimensional stability—is standard on all Dayton TuffPunch® products. For additional information, see p. 2.

FDS
FIRM DELIVERY SCHEDULE

Round 1 Day
Shape 2 Days

TuffPunch® Jektol® Center Dowel Blanks

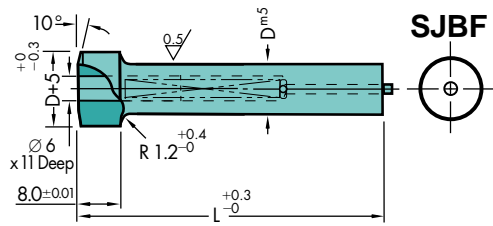

HOW TO ORDER

Specify:	Qty.	Type	D Code	L
Example:	9	SJBF	38	120

Material
Steel: PS4 (CPM M4), RC 60-62
Heads RC 40-55

Jektol® side hole position allows alternate point length shown on SJ_F above.

Standard Alterations
See p.9 for additional ordering instructions.

Shank D	Catalog Number	L					Jektol® Group
		80	90	100	110	120	
10	SJBF 10	●	●	●	●	●	J6M
13	SJBF 13	●	●	●	●	●	J6M
16	SJBF 16	●	●	●	●	●	J9M
20	SJBF 20	●	●	●	●	●	J9M
25	SJBF 25	●	●	●	●	●	J9M
32	SJBF 32	●	●	●	●	●	J9M
38	SJBF 38	●	●	●	●	●	J9M
45	SJBF 45	●	●	●	●	●	J9M

FDS
FIRM DELIVERY SCHEDULE

Blanks 1 Day

Surface Coatings
See p.2 for details.

Code/Added Delivery	Days
XCN —TiCN	+3 days
XN —DayTride®	+3 days
XNT —DayTiN®	+3 days

Note: *DayKool™ (XCR)*—a cryogenic steel conditioning process used primarily with hard, thick materials to improve strength, toughness, and dimensional stability—is standard on all Dayton TuffPunch® products. For additional information, see p. 2.

TuffPunch® Regular Center Dowel Punches

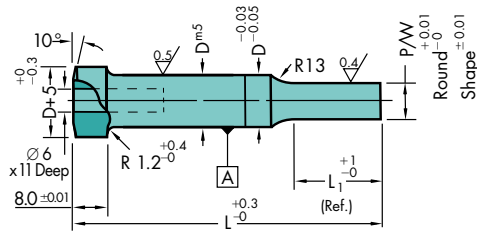
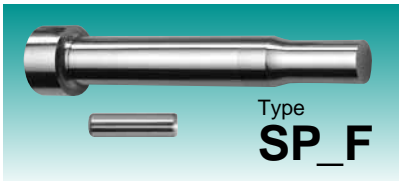

HOW TO ORDER

Specify:	Qty.	Type	D Code	L	P (or P&W) Dimension
Example:	10	SPXF	20	90	P 13.3
	16	SPRF	25	80	P 19.5, W 9.0
	16	SPLF	20	90	P 13.2, W 7.2

Material

Steel: PS4 (CPM M4), RC 60-62
Heads RC 40-55

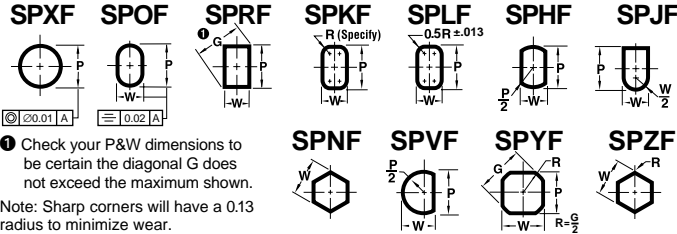

Note: The standard location of a key flat is parallel to the P dimension. For additional information, see p.10.

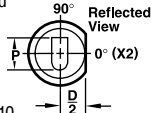

Standard Alterations

See p.9 for additional ordering instructions.

Surface Coatings

See p.2 for details.

Code/Added Delivery	
XCN —TiCN	+3 days
XN —DayTride®	+3 days
XNT —DayTiN®	+3 days



Round 1 Day
Shape 2 Days

Shank D	Point Length L ₁		Type & D SPXF	Range P	Type & D SP_F	Min. W	Max. P/G	L					
	Std.	Alt.						80	90	100	110	120	130
10	13	19	SPXF 10	3.00 – 9.99	SP_F 10	3.00–10.00	●	●	●	●	●	●	
13	13	19	SPXF 13	6.00–12.99	SP_F 13	3.00–13.00	●	●	●	●	●	●	
16	19	25	SPXF 16	10.00–15.99	SP_F 16	4.00–16.00	●	●	●	●	●	●	
20	19	25	SPXF 20	13.00–19.99	SP_F 20	5.00–20.00	●	●	●	●	●	●	
25	19	25	SPXF 25	18.00–24.99	SP_F 25	6.00–25.00	●	●	●	●	●	●	
32	19	25	SPXF 32	20.00–31.99	SP_F 32	6.00–25.00	●	●	●	●	●	●	
38	19	25	SPXF 38	28.00–37.99	SP_F 38	6.00–25.00	●	●	●	●	●	●	
45	19	25	SPXF 45	35.00–44.99	SP_F 45	6.00–25.00	●	●	●	●	●	●	

Note: DayKool™ (XCR)—a cryogenic steel conditioning process used primarily with hard, thick materials to improve strength, toughness, and dimensional stability—is standard on all Dayton TuffPunch® products. For additional information, see p. 2.

TuffPunch® Regular Center Dowel Blanks

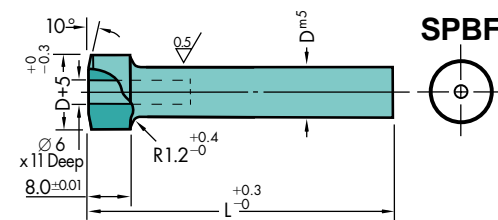
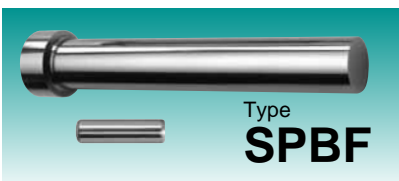

HOW TO ORDER

Specify:	Qty.	Type	D Code	L
Example:	6	SPBF	25	110

Standard Alterations

See p.9 for additional ordering instructions.



Blanks 1 Day

Shank D	Catalog Number	L					
		80	90	100	110	120	130
10	SPBF 10	●	●	●	●	●	●
13	SPBF 13	●	●	●	●	●	●
16	SPBF 16	●	●	●	●	●	●
20	SPBF 20	●	●	●	●	●	●
25	SPBF 25	●	●	●	●	●	●
32	SPBF 32	●	●	●	●	●	●
38	SPBF 38	●	●	●	●	●	●
45	SPBF 45	●	●	●	●	●	●

Note: DayKool™ (XCR)—a cryogenic steel conditioning process used primarily with hard, thick materials to improve strength, toughness, and dimensional stability—is standard on all Dayton TuffPunch® products. For additional information, see p. 2.

Surface Coatings

See p.2 for details.

Code/Added Delivery	
XCN —TiCN	+3 days
XN —DayTride®	+3 days
XNT —DayTiN®	+3 days

TuffPunch® Single Head Retainers

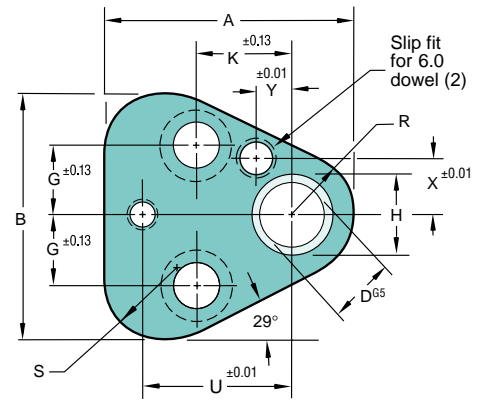

HOW TO ORDER

Specify:	Qty.	Type	D
Example:	4	ARTF	10
	6	ARTFS	25

ARTF and ARTFS TuffPunch® Retainer sets include:

- 2 Screws
- 2 Dowels

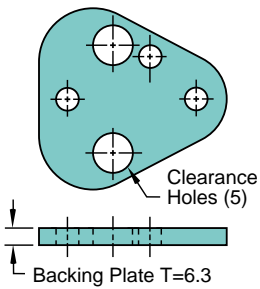
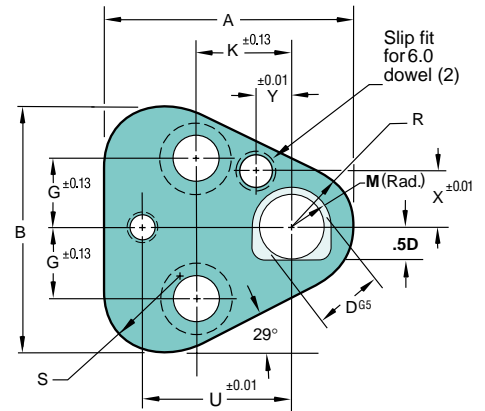

Backing Plate	
D	Catalog No.
10	URBP 10 63
13	URBP 13 63
16	URBP 16 63
20	URBP 20 63
25	URBP 25 63

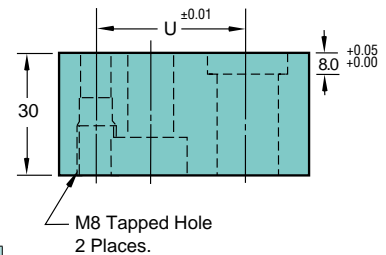

Catalog No.		D	A	B	ARTF H	G	K	ARTFS M	R	S	U	X	Y	Screw Size
Type	Code													
ARTF ARTFS	10	10.00	44.5	43.7	15.5	11.1	19.0	7.75	9.5	12.0	26.925	9.0	7.5	M8
	13	13.00	50.8	50.0	18.5	14.3	19.0	9.25	12.7	15.2	29.970	12.0	6.5	M8
	16	16.00	54.0	53.2	21.5	15.9	19.0	10.75	14.3	16.8	31.750	13.5	6.0	M8
	20	20.00	60.3	59.5	25.5	17.5	19.0	12.75	17.5	20.0	33.530	16.5	5.0	M10
	25	25.00	69.9	69.1	30.5	19.8	23.8	15.25	22.2	24.7	40.640	22.0	7.0	M12

Features/Benefits

TuffPunch® ARTF and ARTFS Single Head Punch Retainers are designed specifically for use with TuffPunch® Punches—Jektol® and Regular. Only one dowel is required for round punches, reducing machining time by up to 50%. The in-line center dowel assures precise punch-to-matrix alignment, giving you higher quality parts, longer punch life, and reduced downtime. Shaped punches use a secondary dowel for precise alignment.

Use of the TuffPunch® Center Dowel Punch and Retainer also eliminates hand-fitting, cutting mounting time by nearly 50%. Simply pull the retainer from its box, and screw it into the die set. This TuffPunch® combination gives you true dimensional accuracy every time.



1 Day

Standard Alterations—Punches and Punch Blanks

Standard Alterations

Punches are available in sizes other than those listed on the individual product pages.

Jektole®, Regular, and Center Dowel

XP, XW P & W Dimensions
Smaller than Standard

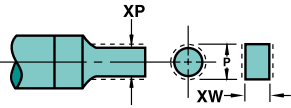

XBR (Straight Before Radius)
It is recommended that point lengths be kept as short as possible for optimum strength.

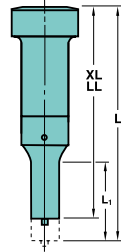
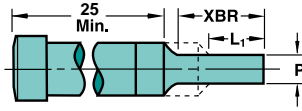

- XL Overall Length Shortened (25 min.)**
Stock removal from point end, which shortens L₁ length.
- XLB Overall Length Shortened**
Stock removal from end point. Point length L₁ maintained. (Min. shank length 25)
- LL Precision Overall Length**
Same as XL except overall length is held to ±0.02.
- XK No Side Hole**
For air ejection. No cost.
- XS Shear Angles**
See information at right.
- XJ Smaller Jektole Components**

L ₁ Max.	8	13	19	25	30	35	40	Jektole® Group
D Code	Min. P (Rounds)							
08	AJXF APXF	3.0 1.5	3.0 1.5	3.0 1.5	4.0 2.0	5.0 2.0	--- 2.0	J4M ---
10	AJXF APXF SJXF SPXF	4.0 1.5 4.0 1.5	4.0 1.5 4.0 1.5	4.0 1.5 4.0 1.5	4.0 2.0 4.0 2.0	5.0 2.0 5.0 2.0	5.0 2.0 5.0 2.0	J6M --- J6M ---
13	AJXF APXF SJXF SPXF	4.0 3.0 --- 3.0	4.0 3.0 4.0 3.0	4.0 3.0 4.0 3.0	4.0 3.0 4.0 3.0	5.0 3.0 5.0 3.0	5.0 3.0 5.0 3.0	J6M --- J6M ---
16	AJXF APXF SJXF SPXF	6.0 5.0 --- 5.0	6.0 5.0 6.0 5.0	6.0 5.0 6.0 5.0	6.0 5.0 6.0 5.0	6.0 5.0 6.0 5.0	6.0 5.0 6.0 5.0	J9M --- J9M ---
20	AJXF APXF SJXF SPXF	6.0 6.0 --- 6.0	6.0 6.0 6.0 6.0	6.0 6.0 6.0 6.0	6.0 6.5 7.6 6.5	6.0 6.5 7.6 6.5	6.0 6.5 7.6 6.5	J9M --- J9M ---
25	AJXF APXF SJXF SPXF	8.0 8.0 --- 8.0	8.0 8.0 8.0 8.0	8.0 8.0 8.0 8.0	8.0 8.0 10.0 9.0	8.0 9.0 10.0 9.0	8.0 9.0 10.0 9.0	J9M --- J9M ---
32	SJXF SPXF	--- 8.0	10.0 8.0	10.0 8.0	10.0 8.0	10.0 9.0	10.0 9.0	J9M ---
38	SJXF SPXF	--- 8.0	10.0 8.0	10.0 8.0	10.0 8.0	10.0 9.0	10.0 9.0	J9M ---
45	SJXF SPXF	--- 8.0	10.0 8.0	10.0 8.0	10.0 8.0	10.0 9.0	10.0 9.0	J9M ---

L ₁ Max.	8	13	19	25	30	35	40	Jektole® Group
D Code	Min. P (Shapes)							
08	AJ_F AP_F	3.0 1.0	3.0 1.5	3.0 3.0	4.0 3.0	4.0 4.0	--- 5.0	J4M ---
10	AJ_F AP_F SJ_F SP_F	4.0 1.25 4.0 1.25	4.0 1.5 4.0 1.5	4.0 3.0 4.0 3.0	4.0 3.0 4.0 3.0	4.0 3.0 4.0 3.0	5.0 5.0 4.5 5.0	J6M --- J6M ---
13	AJ_F AP_F SJ_F SP_F	4.0 1.5 --- 1.5	4.0 1.5 4.0 1.5	4.0 3.0 4.0 3.0	4.0 3.0 4.0 3.0	4.0 3.0 4.0 3.0	5.0 5.0 4.5 5.0	J6M --- J6M ---
16	AJ_F AP_F SJ_F SP_F	6.0 2.0 --- 2.0	6.0 2.0 6.0 2.0	6.0 3.0 6.0 3.0	6.0 3.5 6.0 3.5	6.0 5.0 6.0 5.0	6.0 6.0 6.0 6.0	J9M --- J9M ---
20	AJ_F AP_F SJ_F SP_F	6.0 2.5 --- 2.5	6.0 2.5 6.0 2.5	6.0 3.0 6.0 3.0	6.0 3.5 6.0 3.5	6.0 5.0 6.0 5.0	6.0 6.0 6.0 6.0	J9M --- J9M ---
25	AJ_F AP_F SJ_F SP_F	6.0 3.0 --- 8.0	6.0 3.0 6.0 8.0	6.0 3.0 6.0 8.0	6.0 3.5 6.0 8.0	6.0 5.0 6.0 9.0	6.0 6.0 6.0 9.0	J9M --- J9M ---
32	SJ_F SP_F	--- 3.0	7.2 3.0	7.2 3.0	7.2 3.5	7.2 5.0	7.2 6.0	J9M ---
38	SJ_F SP_F	--- 3.0	7.2 3.0	7.2 3.0	7.2 3.5	7.2 5.0	7.2 6.0	J9M ---
45	SJ_F SP_F	--- 3.0	7.2 3.0	7.2 3.0	7.2 3.5	7.2 5.0	7.2 6.0	J9M ---

Note: For surface coatings information, see p. 2 and the individual product pages.

Shear Angles (XS)

TuffPunch® products are available in *common shear angle configurations* for all standard shapes. Shear angles are also available for classified shapes as special orders.

Shear angles are available in any angle. Specify angle in whole degrees. If half degree is necessary, specify as a decimal, e.g., 8.5°. (Tolerance on all angles is ±15 minutes.) Use the chart below to determine the product designation, then simply add the alteration code shown next to the drawings, along with the angle desired. Example: APXF 16-90-80 P 8.3 XS20 A5°.

For Round Punches Only

Views are reflected view.

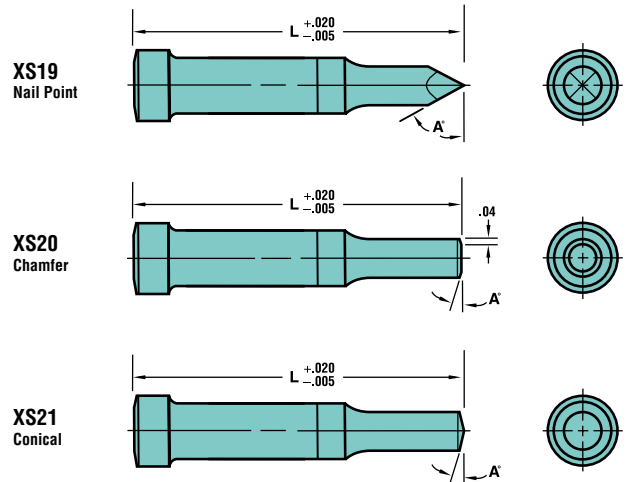

For Round and Shape Punches

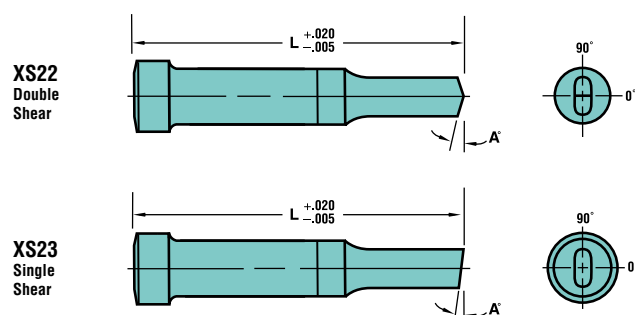

Locking Devices—Flats vs. Dowel Slots

Orientation

The standard location for all locking devices is 0°, and is always on the long side (P) of the shape. Custom locations are measured counterclockwise from 0°.

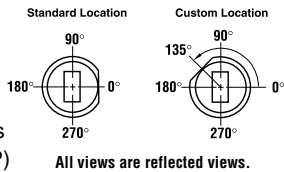

Standard and Alternate Locations

Definitions: **Standard Location** is at 0°. **Alternate Location** is 90°, 180°, or 270°. Alternate locations are available at no additional charge.

Custom Locations

Definitions: **Custom Location** is *any angle other than*: 0°, 90°, 180°, or 270°.

Single Flats

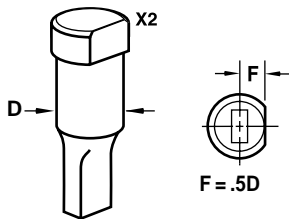

Single Flats: X2

Order Example: X2 — 90°

Single Flats: X5

Order Example: X5 — 135°

Double Flats

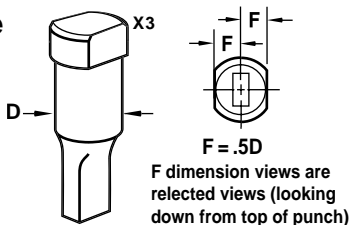

Double Flats: X3

Locking Devices: X3
Order Example: X3 — 90°
Second Flat is *always parallel* to the first flat.

Double Flats: X6

Locking Devices: X6
Order Example: X6 — 135°

Additional Flats

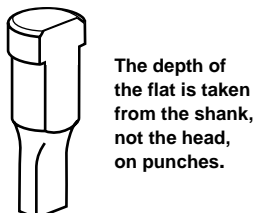

Additional Flats

Code	Depth	Length
X81	1.5	13
X82	1.5	16
X83	1.5	20
X84	1.5	Full Length
X85	2.5	13
X86	2.5	16
X87	2.5	20
X88	2.5	Full Length
X89	Specify Dimensions	

Additional Flats

Code	Depth	Length
X91	1.5	13
X92	1.5	16
X93	1.5	20
X94	1.5	Full Length
X95	2.5	13
X96	2.5	16
X97	2.5	20
X98	2.5	Full Length
X99	Specify Dimensions	

Dowel Slots

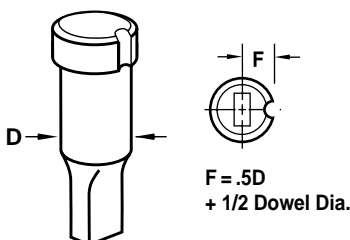

Dowel Slots: X4 & X41

For standard locations, specify **X4** (3.0 Dowel) or **X41** (4.0 Dowel). For alternate locations, specify **X4** or **X41** and degree required.

Order Example: X4 — 90°

Dowel Slots: X7 & X71

Specify **X7** (3.0 Dowel) or **X71** (4.0 Dowel). For custom locations, specify **X7** or **X71** and degree required.

Order Example: X71 — 135°

Location Tolerance

Flat		Dowel	
F	Radial	F	Radial
+ 0.013	.025/25.0 inch	+ 0.013	0°4'
- 0.0		- 0.0	

How To Specify

The most common locking devices—flat, double flat, and dowel—are available. Simply select the type, then add the code to the component description.

HOW TO ORDER

Specify	Qty.	Type	D Code	L	P (or P&W) Dimension	Locking Device
Example:	1	AJRF	16	25-80	P8.5, W.8.0	X2

Other Dayton Products

Ball Lock Punches, Matrixes, Pilots, & Retainers

Dayton *Ball Lock Products* are mainstays in industries with high-demand applications, including automotive and major appliance manufacturing. Because there is no need to pull a die from the press, removal and replacement of worn punches can reduce downtime and improve profitability.

Dayton *True Position® Retainers* (the recognized industry standard) eliminate hand fitting, reduce mounting time, and are ideally suited for both round and complex-shaped products. True Position® allows easy replacement of broken or worn punches.



MaxLife® Die Springs

Dayton *MaxLife® Die Springs* are: made to exact specifications; manufactured to outperform and outlast other major brands; designed specifically for press and mold dies; and ensure optimum operation in heavy industry applications. Corrosion-resistant Dayton die springs are made from pre-tempered chrome silicon wire, and optimize the working life of press and mold dies.



Urethane Stripping & Forming Products

Durable, yet flexible, Dayton urethane strippers and forming products provide superior stripping over conventional strippers; develop higher load-bearing capacity; are tear- and oil-resistant; provide exceptional dampening; and are easy to install and replace.

Dayton dual durometer *SMARTStrip™ Strippers* (two elastomers molded into a single piece) are a cost-effective alternative to metal spring strippers.



Dayton provides a full range of leading-edge die component products: headed punches, guides, and matrixes; positive-locking Ball Lock products; retainers; slug-ejection punches; retaining systems; die springs; and others. For details, contact Dayton Progress or your nearest Dayton Progress Distributor.

© True Position and Max Life are registered trademarks of Dayton Progress.
™ SMARTStrip is a trademark of Dayton Progress.

Commitment to Quality & Customer Satisfaction

Dayton Lamina is a leading manufacturer of tool, die and mold components for the metal-working and plastics industries. As a customer-focused, world-class supplier of choice, we provide the brands, product breadth, distribution network and technical support for all your metal forming needs.

Our goal is to give our customers the most innovative and value-added products and services.



DAYTON Lamina™

a MISUMI Group Company



Lamina® LEMPCO

*Dayton Lamina's line of Danly products is available only to North America.

www.daytonlamina.com