

975 Cottonwood Ave., PO Box 20, Hartland, Wisconsin 53029-0020, USA | www.dorner.com | info@dorner.com

COMMON DRIVE CONVEYOR SETUP

Up to (4) conveyors can be coupled together and driven from a single gearmotor.

- Conveyors move at same relative belt speed.
- Creates single lanes for handling parts.
- Wide parts or pallets can be carried by each conveyor to allow access from below.
- Conveyors can be of different widths and lengths.

Uses Standard 2200 Series End Drive Conveyors

- Aluminum Extruded Frame with T-slot Construction
- Sealed Ball Bearings
- V-Guided and Non-V-Guided Belt Compatible
- Rack and Pinion Belt Tensioning
- Conveyor Widths: 1.75" to 24" wide
- Conveyor Lengths: End Drive = 2' to 18' long
- Belt Speeds: up to 264 ft/min

See Product Engineering Manual or www.dorner.com for details.

Common Drive Specifications

- Drive up to (4) Conveyors from a Single Drive Gearmotor
- Fixed Conveyor Locations
- Load Capacity: Contact Factory for Details
- Compatible with all Standard End Drive Gearmotor Mounting Packages
- Includes Aluminum Extruded Conveyor Tie Bar Assembly with Belt Return Roller
- Includes Common Drive Couplings and Guarding
- Multiple Conveyor Spacing Options
 - 2" Tail Plate to Tail Plate
 - 3" Tail Plate to Tail Plate
 - 4.75" to 24" Tail Plate to Tail Plate



Dimensions & Common Drive Layout

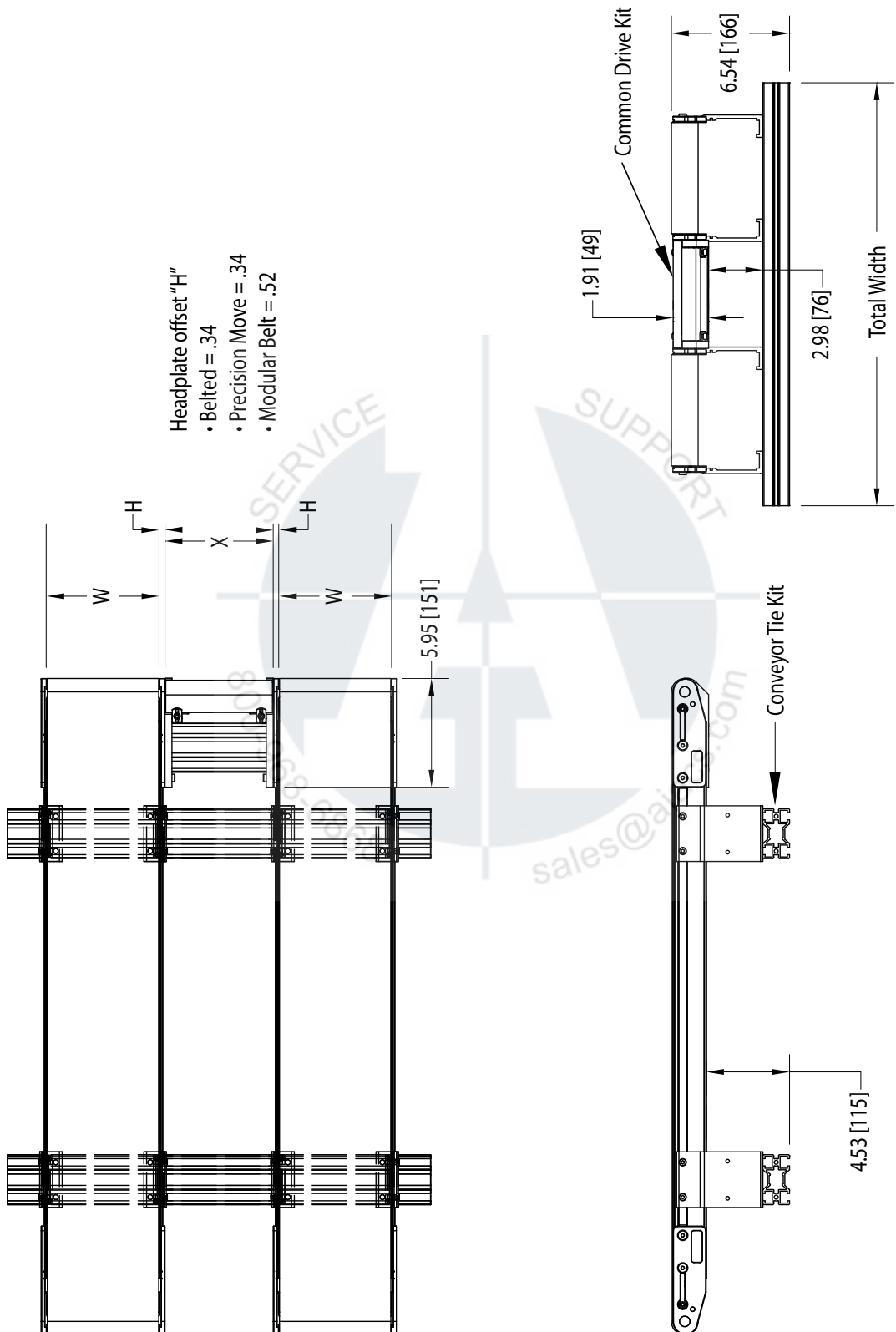

Profiles:

- All 2200 Series profiles are applicable.
- See *Product Engineering Manual* or www.dorner.com for details.

Belting:

- All 2200 Series belting is applicable.
- Finger Splice is preferred, plastic and metal clipper splices are available.
- See *Product Engineering Manual* or www.dorner.com for details.

Mounting Packages & Gearmotors:

- All 2200 Series mounting packages and gearmotors are applicable.
- See *Product Engineering Manual* or www.dorner.com for details.

Support Stands:

- All 2200 Series support stands are applicable.
- See *Product Engineering Manual* or www.dorner.com for details.



Please highlight the conveyor, dimensions, belt flow and motor positions required.

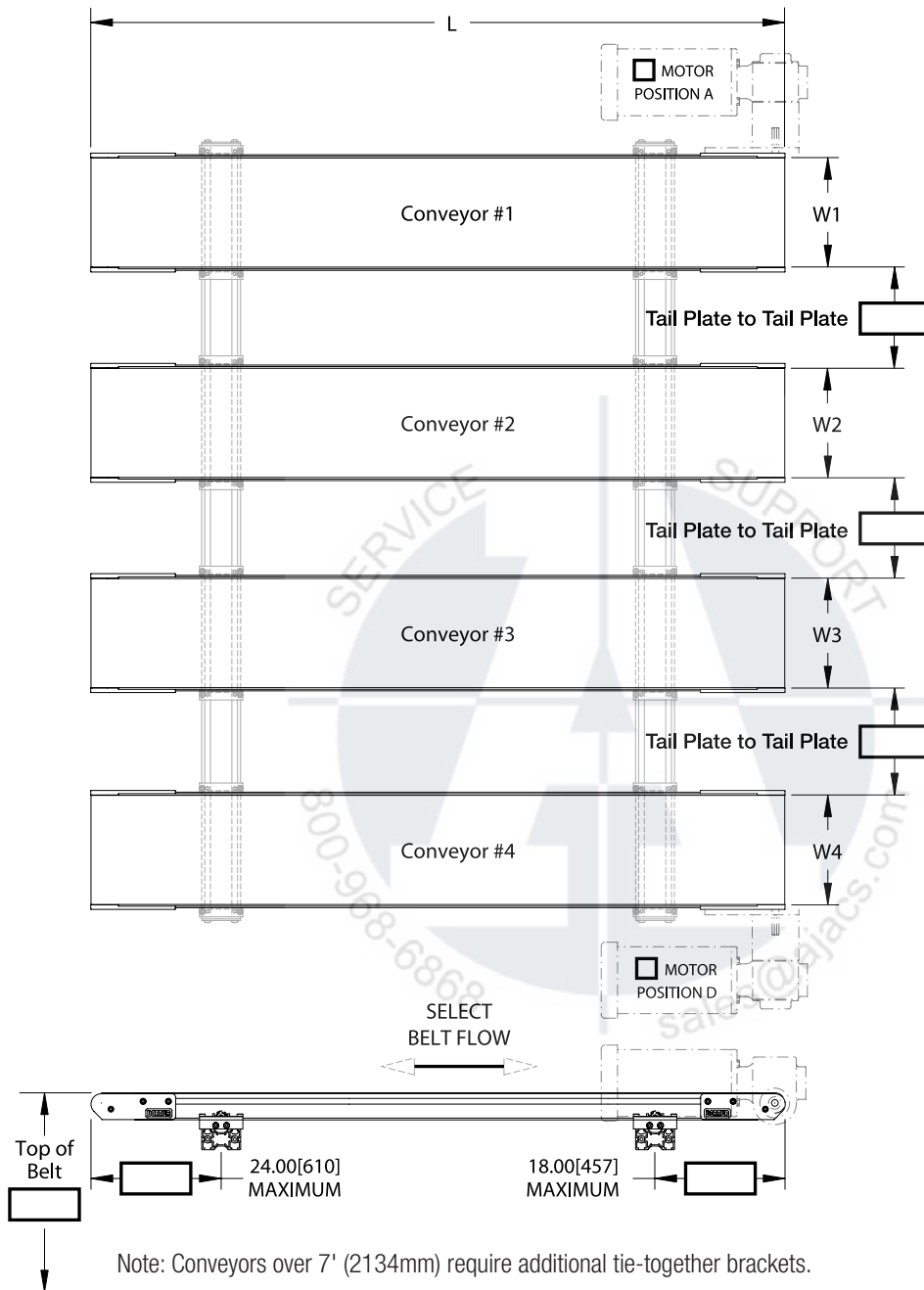

Tail Plate to Tail Plate Options:

- 2"
- 3"
- 4.75" to 24"

Note: Conveyors over 7' (2134mm) require additional tie-together brackets.

Complete the Conveyor Information				
Conveyor	Width (W)	Length (L)	Belt Type*	Profile*
#1				
#2				
#3				
#4				

*See Product Engineering Manual or www.dorner.com for details.

Contact Name:		Project Name:	
Company Name:		DTools Cong #:	
Email:		Phone:	
Address:			

The Basics

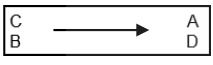

	Conveyor 1	Conveyor 2	Conveyor 3
Belt Widths			
Conveyor Lengths			
Drive Position (side, bottom, top, center)			
Drive Location (C & B reduce load capacity 66%)			
Belt Requirements (Flat or Cleated) (if unsure, describe application)			
Cleat Height (if needed) (see catalog for types)			
Cleat Spacing (if needed)			
Profile / Guiding type (see catalog)			
Top of Belt Heights from Floor (if stands are required) (Infeed and Outfeed)			
Belt Speed (fixed/variable) (Feet per Minute) or (Parts per Minute)			
For Variable Speed: DC or VFD?			
Input Voltage / Phase / HZ			
Stands Needed? Casters or Fixed Feet?			
Curves and LPZ models: attach a sketch with critical dimensions.			
Maximum load on conveyors			
Will parts accumulate? (Stop while belt continues to run)			
Describe how the products are presented to & discharged from conveyor			

The Product

Product Description (shape, material, unique features, sharp edges, fragile, etc)			
Product Dimensions & orientation on the belt			
Part Temperature			
Part Weight			

The Environment

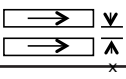
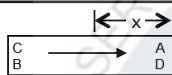
Room temperature or operating temperature near conveyor, if unusual			
Describe any chemicals, lubricants, etc. to contact conveyors?			
Wash down or wipe down? High pressure? (Over 60 psi)?			

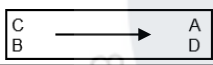
Application Description / Additional Information			
	Conveyor 1	Conveyor 2	Conveyor 3
Enter any other pertinent information here			
Common modifications and additional information needed.			
Magnetic & Vacuum Conveyors			
How are products presented to the conveyor?			
How are products to be removed from conveyor?			
Angle of incline/decline, if any?			
What function is the conveyor expected to perform?			
Are product samples available for testing?			
Specific zone length requirements?			
What forces must the magnets or vacuum resist?			
Common Drive Conveyors			
Size of free & clear gaps required between conveyors			
Quantity of conveyors to be common driven			
Backlit Conveyors			
LED light source type (light color, brightness, etc)			
Zone length			
Zone location along conveyor length from tension end			
Switch plate location (must be within 12" of the light)			
Additional Output Shaft			
Position on conveyor (A, B, C, D)			
Required shaft dimensions			
How is shaft to be used?			
Guiding			
Height from top of belt			
Required width for product			
Lane spacing (if any)			
Material requirements			
How is guiding to be used (create simple lanes, product positioning, etc) ?			
Metal Free Zone Conveyors			
Length of zone			
Why is zone needed (metal detection, X-Ray, etc)			
Complex Projects			
For sophisticated projects, please provide as much of the following information as possible.			
Layout drawings			
Process / sequence of operation descriptions			
Control requirements			
Machine interface needs			
Sample products			
Factory acceptance test requirements			
Installation requirements			

Contact Name:		Project Name:	
Company Name:		DTools Cong #:	
Email:		Phone:	
Address:			

