

JIC Hose Systems

TRADITIONAL HOSE SYSTEM

*RECOMMENDED FOR SERVICING
EXISTING DIES ONLY*

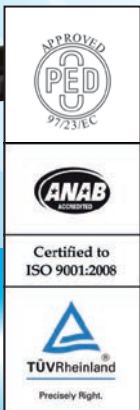

HYSON

RECOMMENDED FOR SERVICING EXISTING DIES ONLY

Table of Contents	Page
Introduction.....	1
Safety Guidelines.....	2
Hose Systems.....	3
Connectors and Adapters	4



General Information

Hyson, headquartered in Brecksville, Ohio, is a world class engineering and manufacturing company that provides high-quality, safety-engineered force control solutions for a wide range of applications and industries, including automotive, aerospace, appliance, medical and HVAC. Hyson partners with our customers to understand applications and provide the best solutions for each one. We are a full service force control provider for critical machine, vehicle and precision metal processing applications, meaning we can supply dependent upon each customer’s needs, including: gas springs, cam systems, cushions, manifolds and knockout systems.

Our success lies with our commitment to continually improve ourselves, our processes and our products to ensure we meet or exceed our customers’ expectations. Our ISO-9001, AS-9000 and PED certifications attest to our ongoing commitment to the highest standards of quality.

Introduction

Connecting nitrogen gas springs via hose or tube offers the distinct advantage of being able to monitor and adjust pressure as well as charge and discharge the springs from outside the die. Hyson features five separate systems for connecting gas springs including DualSeal 24™, Micro24™, O-Ring Face Seal, EZ Hose (CNOMO), and JIC, all of which have undergone rigorous testing including endurance, static leakage and performance.

DualSeal 24™ Hose System – The Preferred Hose System



- Incorporates a dual seal design which utilizes both metal to metal & o-ring sealing, this is ideal for high vibration applications
- Featuring 5mm hose ID offering a high flow rate between springs and external tanks as well as quick charge and drain times
- The 11mm OD hose offers a minimum bend radius of 40mm and minimum hose length of 120mm
- Compatible for hosing springs with G 1/8, 7/16-20 & M6 ports
- Double leak-proof joints and rotational protection

Micro24™– Compact Hose & Tube System

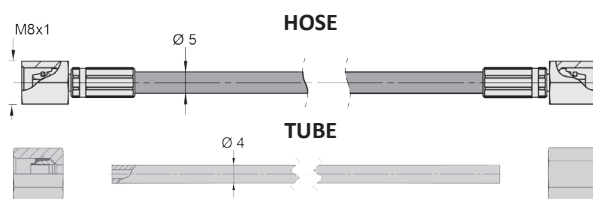

- Featuring a dual seal design which utilizes both metal to metal & o-ring sealing, this is ideal for high vibration applications
- Offers hard tubing options as short as 75mm as well as the smallest hose bend radius of 20mm which allows springs to be connected with minimum center to center distances
- 2mm hose & tube ID limits the speed of charge and drain times
- Compatible for hosing springs with G 1/8, 7/16-20 & M6 ports

O-Ring Face Seal – Traditional High Vibration Hose System



- Used for high vibration applications
- Featuring 6.25mm hose ID offering the highest flow rate between springs & external tanks as well as the fastest charge and drain times
- The large diameter 13mm OD hose requires additional accommodation to account for a minimum bend radius of 51mm and minimum hose length of 152mm
- Compatible for hosing springs with G 1/8 or 7/16-20 ports only
- This system is recommended when high gas flow is required, such as with the CS2 Series of controllable gas springs

EZ – CNOMO Hand Connection Hose System



- Offers hand tightened connections which facilitates easy connection of the hose system with no tool required
- 2mm hose ID limits the speed of charge and drain times
- The 5mm OD hose offers a minimum bend radius of 20mm and minimum hose length of 75mm
- Compatible for hosing springs with G 1/8, 7/16-20 and M6 ports







FEATURED IN THIS CATALOG.... JIC – Traditional Hose System



- Featuring 6.25mm hose ID offering the highest flow rate between springs & external tanks as well as the fastest charge and drain times
- The large diameter 13mm OD hose requires additional accommodation to account for a minimum bend radius of 51mm and minimum hose length of 152mm
- Compatible for hosing springs with G 1/8 or 7/16-20 ports only
- This system is recommended for servicing existing dies only

Safety Guidelines

For safety and optimum performance life:

-  Before connecting gas springs to a hosed system, discharge the nitrogen gas and remove the inlet valve from each spring.
-  Position the control panel in the tool where it will be protected from mechanical damage, and on a higher level than the gas springs to minimize loss of lubrication oil when discharging the gas.
-  Use only nitrogen (N₂) gas. The use of other types of gas can result in personal injury or failure of the gas spring/control panel.
-  Never exceed the maximum charging pressure marked on the gas spring. For most standard gas springs, the maximum charging pressure is 150 bar/2175 psi.
-  All valves on the control panel should be closed during operation.
-  We do not recommend hosing gas springs mounted using FC or FSC flanges as there is a risk that the gas spring will rotate while in operation.
-  Gas springs should be connected in a closed loop to help prevent the pad from tilting during charging.

Control Panel

The Control Panel contains bleed and fill valves and a pressure gauge for charging, exhausting and reading pressure in the system. A rupture disk safety feature is also included to ensure all system pressure is exhausted, keeping springs from becoming over-pressurized in the event the pressure exceeds a safe level for the system.



Control Panel
Order Number CP-N2-T

* Straight Adapter and Mounting Screws are sold separately.

Service Parts	
Order Number	Description
4024535	Bleed Valve
11-700-8555	Fill Valve
51-700-9000-LG	Pressure Gauge
RD-XP	Rupture Disk

Mounting Parts	
Order Number	Description
NF-1000-4-G1/8	Straight Adapter
CS M10-1.5X30MM	Mounting Screws - Metric
CS 3/8-16X1250	Mounting Screws - English

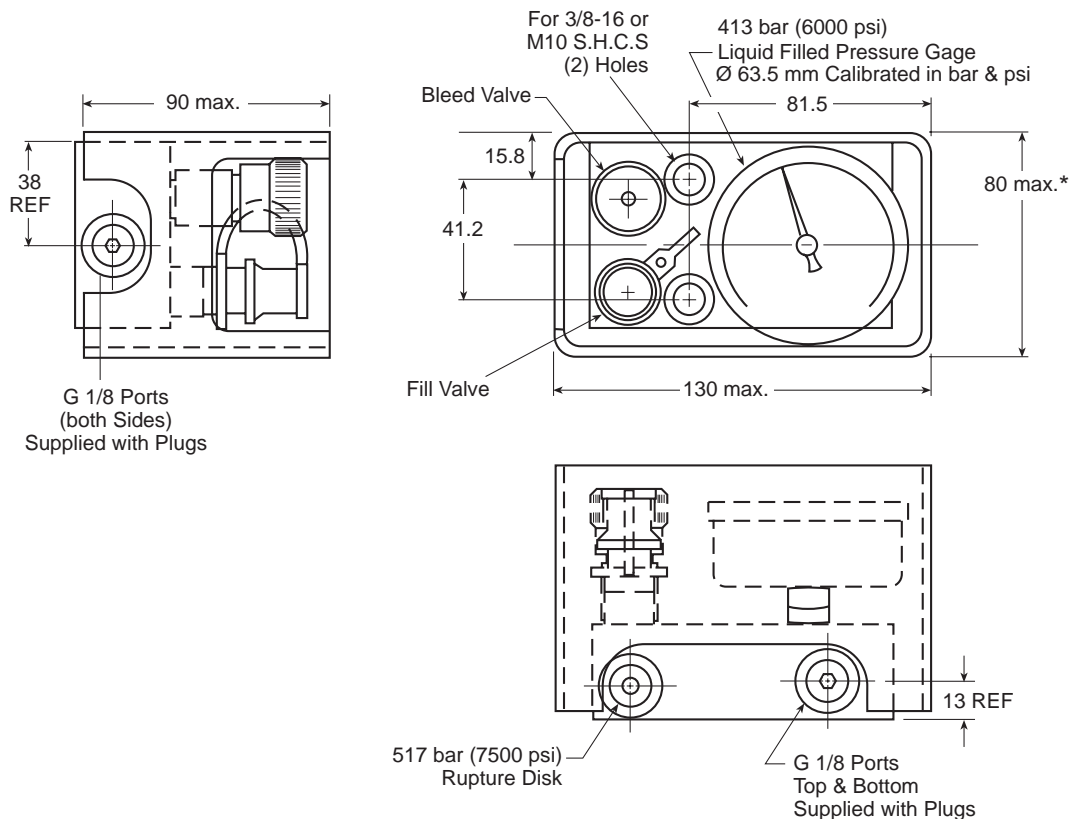

* Includes clearance for button head cap screws

Hose System

Product Specifications

OD 13mm/0.51 in
 ID 6.25mm/0.25 in
 Max. Working Pressure 345 bar/5,000 psi
 Min. Burst Pressure 1380 bar/20,000 psi
 Min. Bend Radius 51mm/2.00 in
 Min. Crimped Hose Length.....150mm/5.91 in (total length with sleeves)



Hose Clip
 Order Number HC-5

Secure hoses using an M6 screw.

Straight – Straight

Order Number SHF-S-S-XXXX

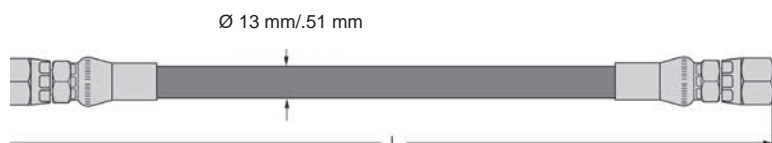

Straight – Straight

Order Number	L (mm)	L (in)
SHF-S-S-0200	200	7.87
SHF-S-S-0300	300	11.81
SHF-S-S-0400	400	15.75
SHF-S-S-0630	630	24.80
SHF-S-S-0800	800	31.50
SHF-S-S-1000	1000	39.37
SHF-S-S-1500	1500	59.06
SHF-S-S-2000	2000	78.74
SHF-S-S-XXXX	XXXX*	XXXX*

Straight – 45°

Order Number SHF-S-45-XXXX



Straight – 45°

Order Number	L (mm)	L (in)
SHF-S-45-0200	200	7.87
SHF-S-45-0300	300	11.81
SHF-S-45-0400	400	15.75
SHF-S-45-0630	630	24.80
SHF-S-45-0800	800	31.50
SHF-S-45-1000	1000	39.37
SHF-S-45-1500	1500	59.06
SHF-S-45-2000	2000	78.74
SHF-S-45-XXXX	XXXX*	XXXX*

Straight – 90°

Order Number SHF-S-90-XXXX

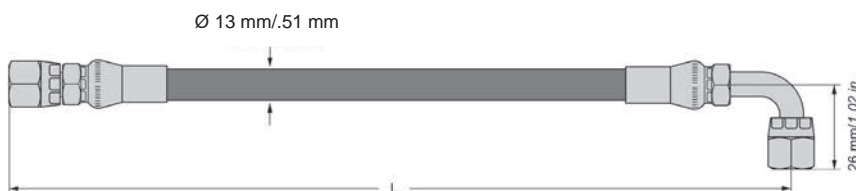

Straight – 90°

Order Number	L (mm)	L (in)
SHF-S-90-0200	200	7.87
SHF-S-90-0300	300	11.81
SHF-S-90-0400	400	15.75
SHF-S-90-0630	630	24.80
SHF-S-90-0800	800	31.50
SHF-S-90-1000	1000	39.37
SHF-S-90-1500	1500	59.06
SHF-S-90-2000	2000	78.74
SHF-S-90-XXXX	XXXX*	XXXX*

JIC Hose

Order Number ORH-4



*** NOTE:** “xxxx” = Assembled hose length in millimeters. Minimum order length is 120mm. Simply add the hose length onto the Order Number (i.e., 3020857–2500 for a Straight-Straight assembly with a 2500mm hose length).

Connectors and Adapters

For JIC Hose Connections for Crimping

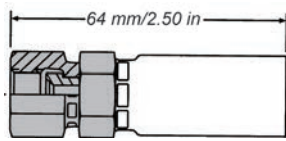

Straight
Order Number SHF-4

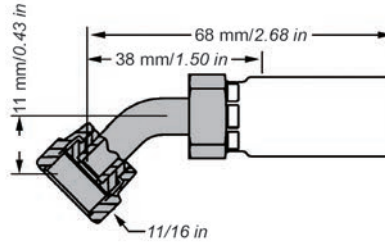

45° Elbow
Order Number NHF-4 45

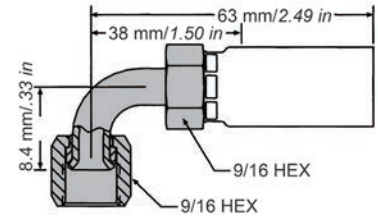

90° Elbow
Order Number NHF-4C 90

Charge Port Adapters

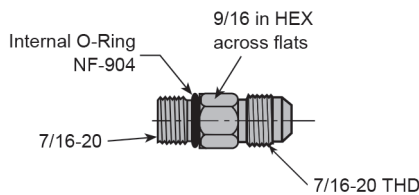

Straight 7/16-20 Adapter
Order Number NF-1000-4

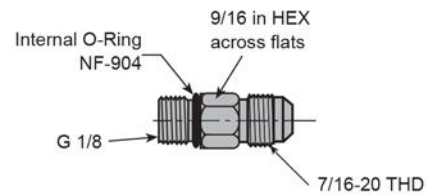

Straight G 1/8 Adapter
Order Number NF-1000-4-G1/8

Adapter-to-Hose Connectors

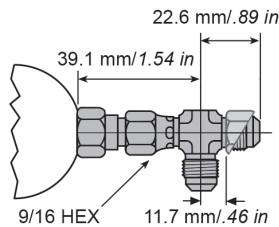

Swivel Nut Run Tee
Order Number NF-3300-4

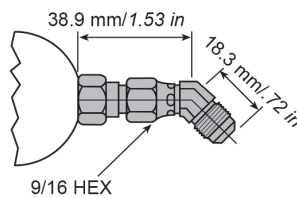

Swivel Nut 45° Elbow
Order Number NF-4500-4

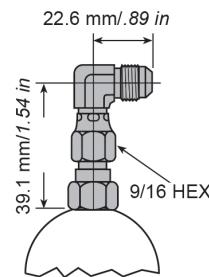

Swivel Nut 90° Elbow
Order Number NF-2000-4

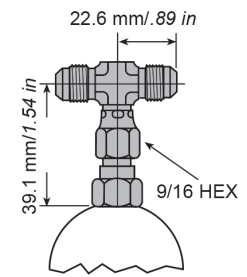

Swivel Nut Branch Tee
Order Number NF-3000-4

Hose-to-Hose Connectors

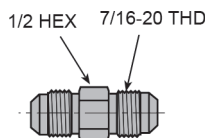

Union
Order Number NF-1100-4

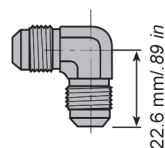

Union Elbow
Order Number NF-2500-4

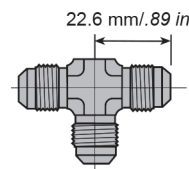

Union Tee
Order Number NF-3500-4

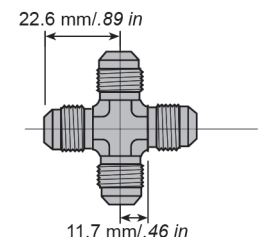

Union Cross
Order Number NF-5500-4



HYSON
METAL FORMING SOLUTIONS™

www.HysonProducts.com
E-mail: hyson@asbg.com

U.S.A. Headquarters • 10367 Brecksville Road • Brecksville, OH 44141 USA • Tel: 800-876-4976, 440-526-5900

©Hyson 2015
JIC 2M 05/15